

Dell M109S Projector

User's Guide

Model: M109S

Notes, Notices, and Cautions



NOTE: A NOTE indicates important information that helps you make better use of your projector.



NOTICE: A NOTICE indicates either potential damage to hardware or loss of data and tells you how to avoid the problem.



CAUTION: A CAUTION indicates a potential for property damage, personal injury, or death.



Complies with IEC 60825-1:1993+A11997+A2:2001 and EN 60825-1:1994+A1:2002+A2:2001
RED: 634 nm, Green: 518nm, Blue: 456nm maximum: 5.38 mW

Information in this document is subject to change without notice.

© 2008 Dell Inc. All rights reserved.

Reproduction of these materials in any manner whatsoever without the written permission of Dell Inc. is strictly forbidden.

Trademarks used in this text: *Dell* and the *DELL* logo are trademarks of Dell Inc.; DLP and DLP® logo are trademarks of TEXAS INSTRUMENTS INCORPORATED; Microsoft, and Windows are either trademarks or registered trademarks of Microsoft Corporation in the United States and/or other countries.

Other trademarks and trade names may be used in this document to refer to either the entities claiming the marks and names or their products. Dell Inc. disclaims any proprietary interest in trademarks and trade names other than its own.

Model M109S

August 2008 Rev. A00

Contents

1	Your Dell™ Projector	5
	About Your Projector	6
2	Connecting Your Projector	7
	Connecting a Computer	8
	Connecting a Computer using a VGA Cable	8
	Connecting a DVD Player	9
	Connecting a DVD Player using a Composite Cable	9
3	Using Your Projector	11
	Turning Your Projector On	11
	Turning Your Projector Off	11
	Adjusting the Projector Focus	12
	Adjusting Projection Image Size	13
	Using the Control Panel	14
	Using the On-Screen Display	16
	Main Menu	16
	AUTO-ADJUST	16
	INPUT SOURCE	16
	PICTURE (in PC Mode)	17
	PICTURE (in Video Mode)	18

DISPLAY (in PC Mode)	19
DISPLAY (in Video Mode).	20
SET UP	20
OTHERS	22
4 Troubleshooting Your Projector	23
5 Specifications	25
6 Contacting Dell™	29
7 Appendix: Glossary	31

Your Dell™ Projector

Your projector comes with all the items shown below. Ensure that you have all the items, contact Dell if anything is missing.

Package Contents

Multi-input cable

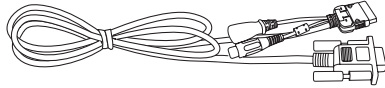

AC adapter

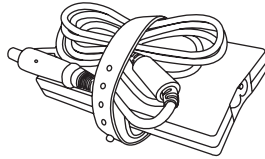

User's guide media &
Documentation

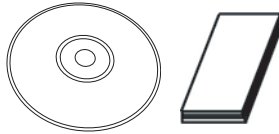

Power cable

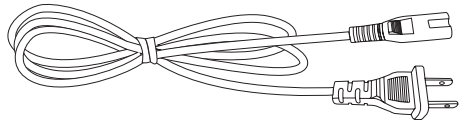

Pouch

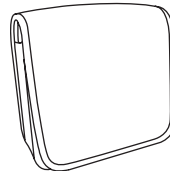

About Your Projector

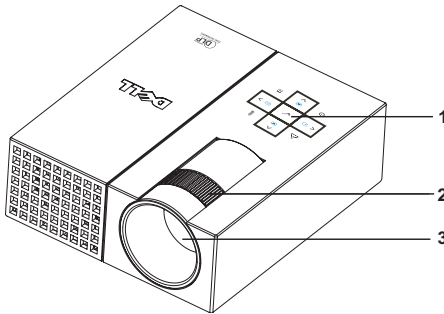

1	Control panel
2	Focus ring
3	Lens

CAUTION: Safety Instructions

- 1 Do not use the projector near appliances that generate a lot of heat.
- 2 Do not use the projector in areas where there is an excessive amount of dust. The dust may cause the system to fail and projector will automatically shutdown.
- 3 Ensure that the projector is placed in a well-ventilated area.
- 4 Do not block the ventilation slots and openings on the projector.
- 5 Ensure the projector operates between ambient temperatures (5°C to 35°C).



NOTE: For more information, see the Product Information Guide that ships with your projector.

Connecting Your Projector

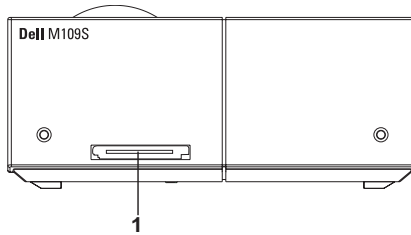

1	Multi-input connector
---	-----------------------



CAUTION: Before you begin any of the procedures in this section, follow the Safety Instructions as described on page 6.

Connecting a Computer

Connecting a Computer using a VGA Cable

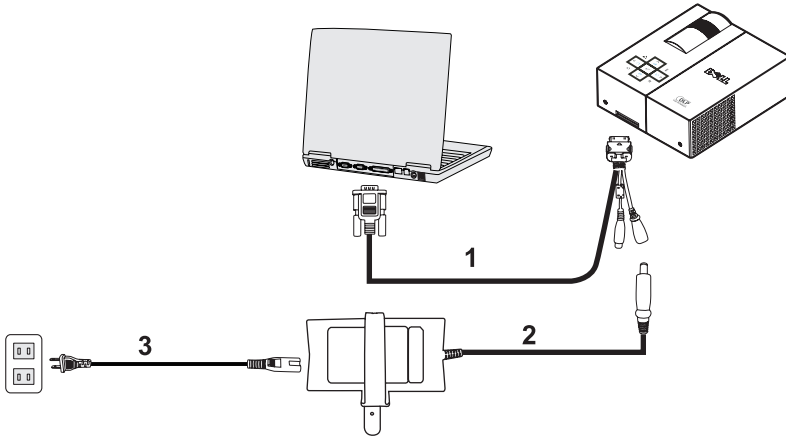

1	Multi-input cable
2	AC adapter
3	Power cord

Connecting a DVD Player

Connecting a DVD Player using a Composite Cable

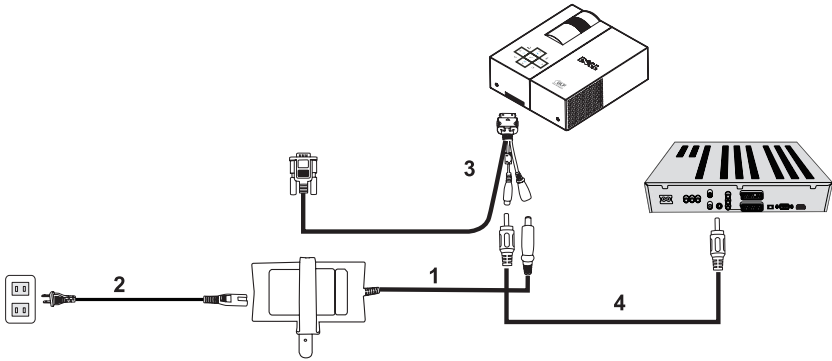

1	AC adapter
2	Power cord
3	Multi-input cable
4	Composite video cable



NOTE: The composite video cable is not provided by Dell.

Using Your Projector

Turning Your Projector On

 **NOTE:** Turn on the projector before you turn on the source. The Power button light blinks blue until pressed.

- 1 Connect the multi-input cable into the projector.
- 2 Connect the multi-input cable with the power cord and appropriate signal cables. For information about connecting the projector, see "Connecting Your Projector" on page 7.
- 3 Press the **Power** button (see "Using the Control Panel" on page 14 to locate the **Power** button).
- 4 Turn on your source (computer, DVD player, etc.). The projector automatically detects your source.
- 5 The Dell Logo will continue for 10 seconds while power on.

If the "Searching for signal..." message appears on the screen, ensure that the appropriate cables are securely connected.

If you have multiple sources connected to the projector, press the **Source** button on the control panel to select the desired source.

Turning Your Projector Off

 **NOTICE:** Unplug the projector after properly shutting down as explained in the following procedure.

- 1 Press the **Power** button.
- 2 Press the **Power** button again. The cooling fans continue to operate for 10 seconds.
- 3 Disconnect the AC adapter from the multi-input cable.
- 4 Disconnect the multi-input cable from the projector.

 **NOTE:** If you press the **Power** button while the projector is running, the "**Press Power Button to Turn off Projector**" message appears on the screen. To clear the message, press the **Menu** button on the control panel or ignore the message; the message disappears after 30 seconds.

Adjusting the Projector Focus

- 1 Rotate the focus ring until the image is clear. The projector focuses at distances ranging between 23.6" to 94.5" (60 cm to 240 cm).
- 2 Move the projector forward or backward to zoom in and out.

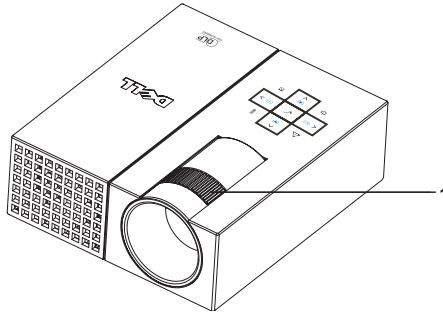

1	Focus ring
---	------------



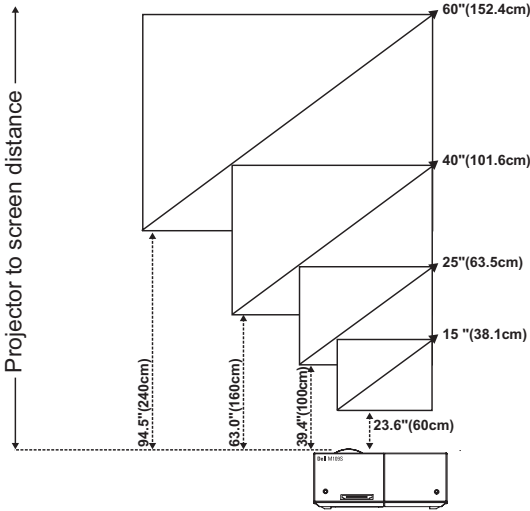

Adjusting Projection Image Size



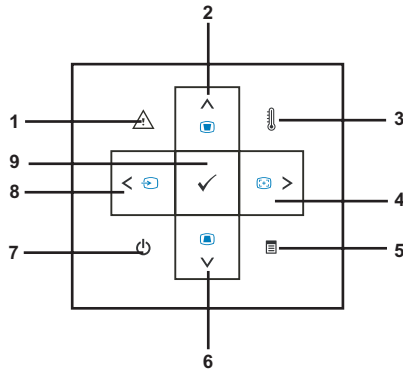







Screen (Diagonal)	Typical	15" (38.1cm)	25" (63.5cm)	40" (101.6cm)	60" (152.4cm)
Screen size (WxH)	Typical	12.3" X 8.6"	20.5" X 14.3"	32.8" X 22.9"	49.2" X 34.4"
		31.2cm X 21.8cm	52.0cm X 36.4cm	83.3cm X 58.2cm	124.9cm X 87.3cm
Distance		23.6" (60cm)	39.4" (100cm)	63.0" (160cm)	94.5" (240cm)
*This graph is for user reference only.					

Using the Control Panel



1	Error LED 	If the error LED is blinking amber, one of the fans has failed. The projector will automatically shut down. If the problem persists, contact Dell™.
2	Up  / Keystone adjustment 	Press to select the On Screen Display (OSD) items. Press to adjust image distortion caused by tilting the projector. (± 20 degrees)
3	Temperature LED 	A solid amber indicates air vents might be blocked or ambient temperature over 35°C. The projector will automatically shut down. Ensure air vents are not blocked and ambient temperature is within operation range. If problem persists, contact Dell™.

4	Right  / Auto Adjust 	Press to adjust the OSD setting. Press to synchronize the projector to the input source. Auto Adjust does not operate if the onscreen display (OSD) is displayed.
5	Menu 	Press to activate the OSD. Use the directional keys and the Menu button to navigate through the OSD.
6	Down  / Keystone adjustment 	Press to select the OSD items. Press to adjust image distortion caused by tilting the projector. (± 20 degrees).
7	Power 	Turn the projector on and off. For more information, see "Turning Your Projector On" on page 11 and "Turning Your Projector Off" on page 11.
8	Left  / Source 	Press to adjust the OSD setting. Press to toggle through Analog RGB and Composite sources when multiple sources are connected to the projector.
9	Enter 	Press to confirm the selection item.

Using the On-Screen Display

The projector has a multi-language On-Screen Display (OSD) that can be displayed with or without an input source present.

To navigate through the tabs in the Main Menu, press the ◀ or ▶ button on the control panel. To select a submenu, press the **Enter** button on the control panel.

To select an option, press the ▲ or ▼ button on the control panel. When an item is selected, the color changes to dark blue. Use the ◀ or ▶ button on the control panel to adjust the settings.

To go back to Main Menu, go to Back tab and press the **Enter** button on the control panel.

To exit the OSD, go to EXIT tab and press the **Enter** button or press the **Menu** button directly on the control panel.

Main Menu



AUTO-ADJUST

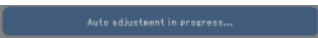

Auto Adjust automatically adjusts the projector's **Frequency** and **Tracking** in PC mode. While Auto Adjustment is in progress, the following message appears on the screen, "**Auto Adjustment in Progress...**".

INPUT SOURCE

The **Input Source** menu allows you to select your projectors input source.



AUTO SOURCE—Select **On** (the default) to auto detect the available input signals. If you press the **Source** button when the projector is on, it automatically finds the next available input signal. Select **Off** to lock the current input signal. If you press the **Source** button when the **Auto Source** mode is set to **Off**, you can manually select the input signal.

VGA—Press **Enter** to detect VGA signal.

COMPOSITE—Press **Enter** to detect Composite Video signal.

PICTURE (in PC Mode)

Using the **Picture** menu, you can adjust the display settings of your projectors. The **Picture** menu provides the following options:

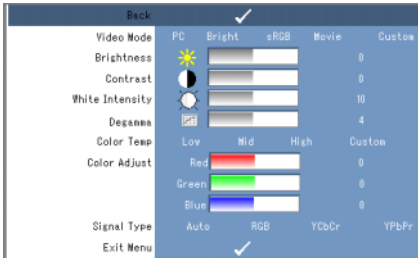

VIDEO MODE—Allows you to optimize the projector’s display mode: **PC**, **Bright**, **sRGB** (provides more accurate color representation), **Movie**, and **Custom** (set your preferred settings). If you adjust the settings for **White Intensity** or **Degamma**, the projector automatically switches to **Custom**.



NOTE: If you adjust the settings for **White Intensity** or **Degamma**, the projector automatically switches to **Custom**.

BRIGHTNESS—Use ⏪ and ⏩ to adjust the brightness of the image.

CONTRAST—Use ⏪ and ⏩ to adjust the display contrast.

WHITE INTENSITY—Set 0 to maximize the color reproduction and 10 to maximize the brightness.

DEGAMMA—Allows you to adjust among the 4 preset values (1, 2, 3, 4) to change the color performance of the display.

COLOR TEMP—Allows you to adjust the color temperature. The screen appears cooler at higher color temperatures and warmer at lower color temperatures. When you adjust the values in the **Color Adjust** menu, the **Custom** mode is activated. The values are saved in the **Custom** mode.

COLOR ADJUST—Allows you to manually adjust the red, green, and blue colors.

SIGNAL TYPE—Manually select signal type Auto, RGB, YCbCr, or YPbPr.

PICTURE (in Video Mode)

Using the **Picture** menu, you can adjust the display settings of your projectors. The

Picture menu provides the following options:

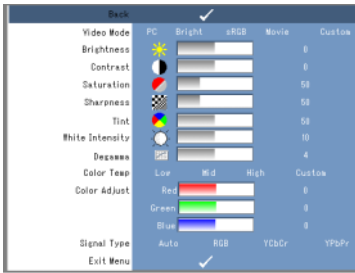

VIDEO MODE—Allows you to optimize the projector’s display mode: **PC**, **Bright**, **sRGB** (provides more accurate color representation), **Movie**, and **Custom** (set your preferred settings). If you adjust the settings for **White Intensity** or **Degamma**, the projector automatically switches to **Custom**.

 **NOTE:** If you adjust the settings for **White Intensity** or **Degamma**, the projector automatically switches to **Custom**.

BRIGHTNESS—Use ◀ and ▶ to adjust the brightness of the image.

CONTRAST—Use ◀ and ▶ to adjust the display contrast.

SATURATION—Allows you to adjust the video source from black and white to fully saturated color. Press ◀ to decrease the amount of color in the image and ▶ to increase the amount of color in the image.

SHARPNESS—Press ◀ to decrease the sharpness and ▶ to increase the sharpness.

TINT—Press ◀ to increase the amount of green in the image and ▶ to increase the amount of red in the image (Selectable for NTSC only).

WHITE INTENSITY—Set 0 to maximize the color reproduction and 10 to maximize the brightness.

DEGAMMA—Allows you to adjust among the 4 preset values (1, 2, 3, 4) to change the color performance of the display.

COLOR TEMP—Allows you to adjust the color temperature. The screen appears cooler at higher color temperatures and warmer at lower color temperatures. When you adjust the values in the **Color Adjust** menu, the **Custom** mode is activated. The values are saved in the **Custom** mode.

COLOR ADJUST—Allows you to manually adjust the red, green, and blue colors.



SIGNAL TYPE—Manually select signal type Auto, RGB, YCbCr, or YPbPr.

DISPLAY (in PC Mode)

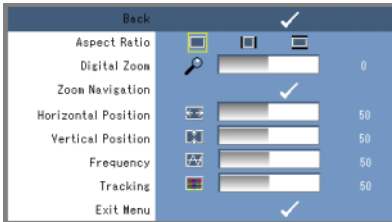
Using the **Display** menu, you can adjust the display settings of your projectors. The **Display** menu provides the following options:





ASPECT RATIO—Allows you to set the aspect ratio.



-  4:3 - The input source scales to fit the screen.
-  Original - The input source scales to fit the screen while keeping the aspect ratio of the input source.
-  Wide - The input source scales to fit the width of the screen.



Use Wide or 4:3 if you are using one of the following:

- Computer resolution greater than SVGA
- Component cable (720p/1080i/1080p)

DIGITAL ZOOM—Press  to digitally magnify an image up to 4 times on the projection screen and press  to reduce the zoomed image.

ZOOM NAVIGATION—Press     to navigate projection screen.

HORIZONTAL POSITION—Press  to move the image to the right and  to move the image to the left.

VERTICAL POSITION—Press  to move the image down and  to move the image up.

FREQUENCY—Allows you to change the display data clock frequency to match the frequency of your computer graphics card. If you see a vertical flickering wave, use **Frequency** control to minimize the bars. This is a coarse adjustment.

TRACKING—Synchronize the phase of the display signal with the graphic card. If you experience an unstable or flickering image, use **Tracking** to correct it. This is a fine adjustment.

DISPLAY (in Video Mode)

Using the **Display** menu, you can adjust the display settings of your projectors. The

Display menu provides the following options:

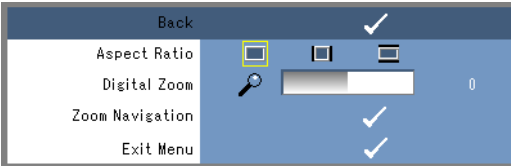

ASPECT RATIO—Allows you to set the aspect ratio.

- 4:3 - The input source scales to fit the screen.
- Original - The input source scales to fit the screen while keeping the aspect ratio of the input source.
- Wide - The input source scales to fit the width of the screen.

Use Wide or 4:3 if you are using one of the following:

- Computer resolution greater than SVGA
- Component cable (720p/1080i/1080p)

DIGITAL ZOOM—Press to digitally magnify an image up to 4 times on the projection screen and press to reduce the zoomed image.

ZOOM NAVIGATION—Press to navigate projection screen.

SET UP

It includes Language, Auto Keystone, Keystone, Menu Position, Menu Transparency, Menu Timeout, Menu Lock, Password, and Change Password settings.

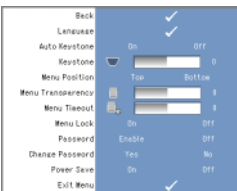

LANGUAGE—Allows you to set the language for the OSD.



AUTO KEYSTONE—Auto adjusts the image distortion by tilting the projector.

KEYSTONE—Adjusts the image distortion caused by tilting the projector.

MENU POSITION—Allows you to select the position of the OSD menu on the screen.

MENU TRANSPARENCY—Select to change the transparency level of the OSD background.

MENU TIMEOUT—Allows you to adjust the time for an OSD Timeout. By default, the OSD disappears after 30 seconds of non-activity.

MENU LOCK—Select **On** to enable **Menu Lock** and hide the OSD menu. Select **Off** to disable the **Menu Lock** and display the OSD menu.



NOTE: If the OSD disappears while you disable **Menu Lock**, press the **Menu** button on the control panel for 15 seconds, then disable the function.

PASSWORD—When Password Protect is enabled, a Password Protect screen requesting you to enter a password will be displayed when the power plug is inserted into the electrical outlet and the power for the projector is first turned on. By default, this function is disabled. You can enable this feature using the Password menu. This password security feature will be activated the next time you turn on the projector. If you enable this feature, you will be asked to enter the projector's password after you turn on the projector:

1 1st time password input request:

- a Go to **Setup** menu, press **Enter** and then select **Password** to **Enable** the password setting.



- b Enable the Password function will pop up a character screen, key in a 4-digit number from the screen and press the **Enter** button.



- c To confirm, enter the password again.
- d If the password verification is successful, you may resume with accessing the projector's functions and its utilities.

2 If you have entered incorrect password, you will be given another 2 chances. After the three invalid attempts, the projector will automatically turn off.

 **NOTE:** If you forget your password, contact DELL™ or qualified service personnel.

3 To cancel the password function, select **Off** and enter the password to disable the function.



CHANGE PASSWORD. Key in the original password, then enter the new password and confirm the new password again.



POWER SAVE. Select On to enable the function. The projector will automatically turn off after 5 minutes.

OTHERS

Back		✓	
Projector Info		✓	
Test Pattern	Off	1	2
Factory Reset	On		Off
Exit Menu		✓	







PROJECTOR INFO—Displays the projector model name, the present input source and projector series number (PPID#).

TEST PATTERN—Select **Off** to disable the function. Select 1 or 2 to activate the built-in Test Pattern for self-testing on focus and resolution.

FACTORY RESET—Select **On** to reset the projector to its factory default settings. Reset items include both computer sources and video source settings.

Troubleshooting Your Projector

If you experience problems with your projector, see the following troubleshooting tips. If the problem persists, contact Dell™. See on page 27.

Problem	Possible Solution
No image appears on the screen	<ul style="list-style-type: none"> • Ensure that the external graphics port is enabled. If you are using a Dell™ portable computer, press   (Fn+F8). For other computers, see your respective documentation. • Ensure that all the cables are securely connected. See on page 7. • Ensure that the pins of the connectors are not bent or broken. • Use Test Pattern in the Others menu. Ensure that the colors of the test pattern are correct.
Partial, scrolling, or incorrectly displayed image	<ol style="list-style-type: none"> 1 Press the Auto Adjust button on control panel. 2 If you are using a Dell™ portable computer, set the resolution of the computer to SVGA (800 x 600): <ol style="list-style-type: none"> a Right-click the unused portion of your Windows desktop, click Properties and then select Settings tab. b Verify the setting is 800 x 600 pixels for the external monitor port. c Press   (Fn+F8). <p>If you experience difficulty in changing resolutions or your monitor freezes, restart all the equipments and the projector.</p> <p>If you are not using a Dell™ portable computer, see your documentation.</p> <p>If problem persists, upgrade your computer graphic card driver (video driver) to its latest version and test again with projector.</p>
The screen does not display your presentation	<p>If you are using a portable computer, press   (Fn+F8).</p>

Problem (continued)	Possible Solution (continued)
Image is unstable or flickering	Adjust the Tracking in the OSD Display submenu (in PC Mode only).
Image has vertical flickering bar	Adjust the Frequency in the OSD Display submenu (in PC Mode only).
Image color is incorrect	<ul style="list-style-type: none"> • If the display receives the wrong signal output from the graphics card, please set the signal type to RGB in the OSD Display tab. • Use Test Pattern in the Others menu. Ensure that the colors of the test pattern are correct.
Image is out of focus	<ol style="list-style-type: none"> 1 Adjust the focus ring on the projector lens. 2 Ensure that the projection screen is within the required distance from the projector (23.6" [60 cm] to 94.5" [240 cm]).
The image is stretched when displaying a 16:9 DVD	<p>The projector automatically detects the input signal format. It will maintain the aspect ratio of the projected image according to input signal format with an Original setting.</p> <p>If the image is still stretched, adjust the aspect ratio in the Display menu in the OSD.</p>
Temperature LED is solid amber	The projector has overheated. The display automatically shuts down. Turn the display on again after the projector cools down. If the problem persists, contact Dell™.
Error LED is blinking amber	A projector fan has failed and the projector will automatically shut down. If the problem persists, contact Dell™.
The OSD does not appear on the screen	Try to press the Menu button on the panel for 15 seconds to unlock the OSD. Check the Menu Lock on page 21.

Specifications

Light Valve	0.45" SVGA DMD Type Y
Brightness	50 ANSI Lumens (Max)
Contrast Ratio	800:1 Typical (Full On/Full Off)
Uniformity	80% Typical (Japan Standard - JBMA)
Light Source	R/G/B LED module
Number of Pixels	858 x 600
Displayable Color	16.7M colors
Projection Lens	F/2.0, f=17.67mm fixed lens
Projection Screen Size	15 - 60 inches (diagonal)
Projection Distance	23.6 - 94.5 inches (60cm - 240cm)
Video Compatibility	NTSC, NTSC 4.43, PAL, PAL-M, PAL-N, SECAM, and HDTV (1080i, 720P, 576i/P, 480i/P) compatibility Composite video and Component video
H. Frequency	15kHz-100kHz (Analog)
V. Frequency	43Hz-85Hz (Analog)
Power Supply	+19.5V DC
Power Consumption	47 Watts (Max), < 1 Watt at power off mode
Noise Level	32dB (A) (Normal Mode) 35dB (A) (Bright Mode)
Weight	360g (0.80 lbs)
Dimensions (W x H x D)	External 3.64 x 4.12 x 1.46 ± 0.04 inches (92.5 x 104.6 x 37.1 ± 1mm)
I/O Connectors	30 PIN multi-input connector

Compatibility Modes (Analog)

Resolution	V. Frequency (Hz)	H. Frequency (KHz)
640X350	70.1	31.5
720X400	70.1	31.5
640X480	59.9	31.5
640X480	75	37.5
640X480	85	36
800X600	60.3	37.9
800X600	75	46.9
800X600	85.1	53.7
1024X768	60	48.4
1024X768	75	60
1024X768	85	68.7
1152X864	75	67.5
1280X1024	60	64
1280X1024	75	80
1280X1024	85	91.1
1440X900	60	55.5

Contacting Dell™

For customers in the United States, call 800-WWW-DELL (800-999-3355).



NOTE: If you do not have an active Internet connection, you can find the contact information on your purchase invoice, packing slip, bill, or Dell product catalog.

Dell provides several online and telephone-based support and service options. Availability varies by country and product, and some services may not be available in your area. To contact Dell for sales, technical support, or customer service issues:

- 1 Visit support.dell.com.
- 2 Verify your country or region in the **Choose A Country/Region** dropdown menu at the bottom of the page.
- 3 Click **Contact Us** on the left side of the page.
- 4 Select the appropriate service or support link based on your need.
- 5 Choose the method of contacting Dell that is convenient for you.

Appendix: Glossary

ANSI Lumens—A standard for measuring the brightness. It is calculated by dividing a square meter image into nine equal rectangles, measuring the lux (or brightness) reading at the center of each rectangle, and averaging these nine points.

Aspect Ratio—The most popular aspect ratio is 4:3 (4 by 3). Early television and computer video formats are in a 4:3 aspect ratio, which means that the width of the image is 4/3 times the height.

Brightness—The amount of light emitting from a display or projection display or projection device. The brightness of projector is measured by ANSI lumens.

Color Temperature—The color appearance of white light. Low color temperature implies warmer (more yellow/red) light while high color temperature implies a colder (more blue) light. The standard unit for color temperature is Kelvin (K).

Component Video—A method of delivering quality video in a format that contains all the components of the original image. These components are referred to as luma and chroma and are defined as Y'Pb'Pr' for analog component and Y'Cb'Cr' for digital component. Component video is available on DVD players and projectors.

Composite Video—A video signal that combines the luma (brightness), chroma (color), burst (color reference), and sync (horizontal and vertical synchronizing signals) into a signal waveform carried on a single wire pair. There are three kind of formats, namely, NTSC, PAL and SECAM.

Compressed Resolution—If the input images are of higher resolution than the native resolution of the projector, the resulting image will be scaled to fit the native resolution of the projector. The nature of compression in a digital device means that some image content is lost.

Contrast Ratio—Range of light and dark values in a picture, or the ratio between their maximum and minimum values. There are two methods used by the projection industry to measure the ratio:

- 1 *Full On/Off* — measures the ratio of the light output of an all white image (full on) and the light output of an all black (full off) image.
- 2 *ANSI* — measures a pattern of 16 alternating black and white rectangles. The average light output from the white rectangles is divided by the average light output of the black rectangles to determine the ANSI contrast ratio.

Full On/Off contrast is always a larger number than ANSI contrast for the same projector.

dB—decibel—A unit used to express relative difference in power or intensity, usually between two acoustic or electric signals, equal to ten times the common logarithm of the ratio of the two levels.

Diagonal Screen—A method of measuring the size of a screen or a projected image. It measures from one corner to the opposite corner. A 9ft high, 12ft wide, screen has a diagonal of 15ft. This document assumes that the diagonal dimensions are for the traditional 4:3 ratio of a computer image as per the example above.

DLP[®]—Digital Light Processing — Reflective display technology developed by Texas Instruments, using small manipulated mirrors. Light passes through a color filter is sent to the DLP mirrors which arrange the RGB colors into a picture projected onto screen, also known as DMD.

DMD—Digital Micro-Mirror Device — Each DMD consists of thousands of tilting, microscopic aluminum alloy mirrors mounted on a hidden yoke.

Focal Length—The distance from the surface of a lens to its focal point.

Frequency— It is the rate of repetition in cycles per seconds of electrical signals. Measured in Hz (Hertz).

Hz (Hertz)—Unit of frequency.

Keystone Correction—Feature that will correct a projected image with distortion (wide-top narrow bottom effect) caused by improper projector to screen angle placement.

Maximum Distance—The distance the projector can throw a usable (bright enough) image onto the screen in a fully darkened room.

Maximum Image Size—The largest image a projector can throw in a darkened room. This is usually limited by focal range of the optics.

Minimum Distance—The closest position that a projector can focus an image onto a screen.

NTSC—National Television Standards Committee. North American standard for video and broadcasting, with a video format of 525 lines at 30 frames per second.

PAL—Phase Alternating Line. A European broadcast standard for video and broadcasting, with a video format of 625 lines at 25 frames per second.

RGB—Red, Green, Blue — typically used to describe the separate signals for each of the three colors.

SECAM—A French and international broadcast standard for video and broadcasting. Higher resolution than NTSC.

SVGA—Super Video Graphics Array — 800 x 600 pixels count.

SXGA—Super Extended Graphics Array, — 1280 x 1024 pixels count.

UXGA—Ultra Extended Graphics Array — 1600 x 1200 pixels count.

VGA—Video Graphics Array — 640 x 480 pixels count.

XGA—Extra Video Graphics Array — 1024 x 768 pixels count.

Index

A

Adjusting the Projector Focus
Focus ring, 12

C

Connecting the Projector
AC adapter, 8
Composite video cable, 9
Connecting with a Composite
Cable, 9
Multi-input cable, 8
Power cord, 9

Connection Port
Multi-input connector, 7

D

Dell
contacting, 27

M

Main Unit
Control panel, 6
Focus ring, 6
Lens, 6

O

On-Screen Display, 16
AUTO-ADJUST, 16
DISPLAY (in PC Mode), 19
DISPLAY (in Video Mode), 19
INPUT SOURCE, 16
Main Menu, 16
OTHERS, 22

PICTURE (in PC Mode), 17
PICTURE (in Video Mode), 17
SET UP, 20

P

Powering On/Off the Projector
Powering Off the Projector, 11
Powering On the Projector, 11

S

Specifications
Brightness, 25
Contrast Ratio, 25
Dimensions, 25
Displayable Color, 25
H. Frequency, 25
I/O Connectors, 25
Light Source, 25
Light Valve, 25
Noise Level, 25
Number of Pixels, 25
Power Consumption, 25
Power Supply, 25
Projection Distance, 25
Projection Lens, 25
Projection Screen Size, 25
Uniformity, 25
V. Frequency, 25
Video Compatibility, 25
Weight, 25

support
contacting Dell, 27

T

Troubleshooting, 23
 contact Dell, 24